

СЪДЪРЖАНИЕ

стр.

Панти, Телескопични водачи, Газови амортисьори

Панти "ТМ" Ф35.....	Made in Italy	2-3
Панти Стандарт Ф35, Панти с плавно прибиране Ф35.....		4
Телескопични водачи, Газови амортисьори.....		5

Сглобки, Рафтодържачи, Ъгли

Сглобки.....	Made in Italy	6
Рафтодържачи.....	Made in Italy	7
Ъгли.....		8-9

Лостове, Крака, Колела, Ключалки, Офис аксесоари

Лостове, Изтеглящ лост.....		10
Кухненски крака.....	Made in Italy	11
Крака, Колела, Ключалки.....		12
Офис аксесоари.....		13

Водобранни лайсни, Цокли, Профили

Водобрани лайсни, Профили челен борд.....	Made in Italy	14
Цокли, Профили за витрина.....	Made in Italy	15

Дръжки, Закачалки

Дръжки.....	Made in Italy	16-19
Дръжки алуминиеви.....		20
Дръжки.....		21
Закачалки.....		22

Аксесоари - Отцедници, Кошчета, Разделители за прибори

Отцедници.....	Made in Italy	23
Кошчета.....	Made in Italy	24-25
Разделители за прибори.....	Made in Italy	26-28

Телени аксесоари за кухни и гардероби

Телени аксесоари.....	STARAX	29
Телени аксесоари.....	STARAX	30-31
Телени аксесоари.....	STARAX	32-33
Телени аксесоари, Лифт за гардероб.....	STARAX	34-35

Мивки, Батерии

Мивки алпака.....		36-37
Мивки гранитни и батерии.....		38-39

Осветление.....		40-41
-----------------	--	-------

Планки за греди.....		42-44
----------------------	--	-------

Панти “ТМ” Ф35



Панта “ТМ” покрит кант



Панта “ТМ” полупокрит кант



Панта “ТМ” открит кант



Пластина за панта “ТМ”



Пластина за панта “ТМ” с 4 отвора



Панта "ТМ" +90°



Панта "ТМ" +45°



Панта "ТМ" +90° късо тяло



Панта "ТМ" +30°

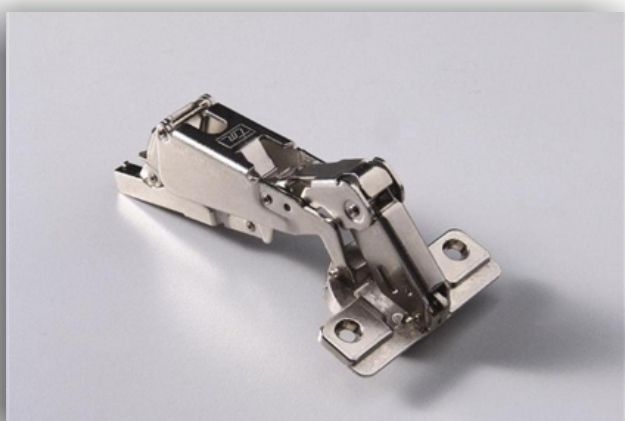

Панта "ТМ" +165°



Панта "ТМ" ъглова



Панта Стандарт покрит кант



Панта Стандарт полу покрит кант



Панта Стандарт открит кант

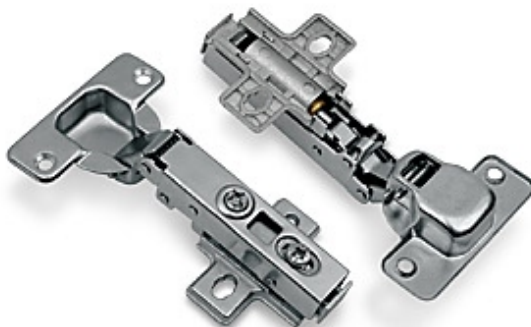

Панта с амортизатор
плавно прибиране

МОДЕЛ
покрит кант
полупокрит кант
открит кант

Телескопичен водач Н=45
100% изтегляне

ДЪЛЖИНА / мм /
250
300
350
400
450
500
550
600
700

**Газов амортисьор за вдигаща врата**

80N
100N
120N

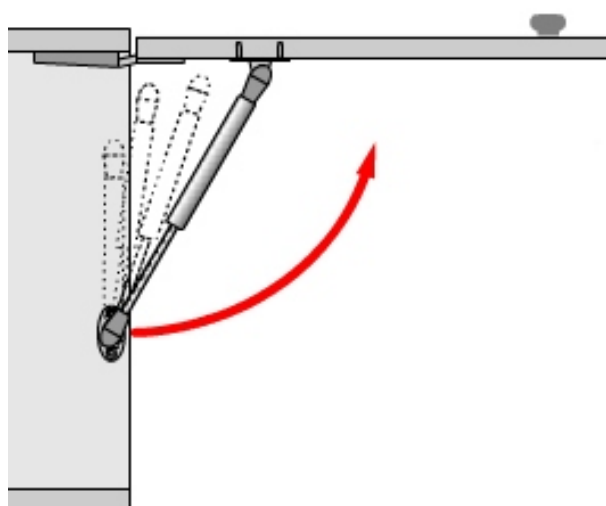
**Газов амортисьор за падаща врата**

60N

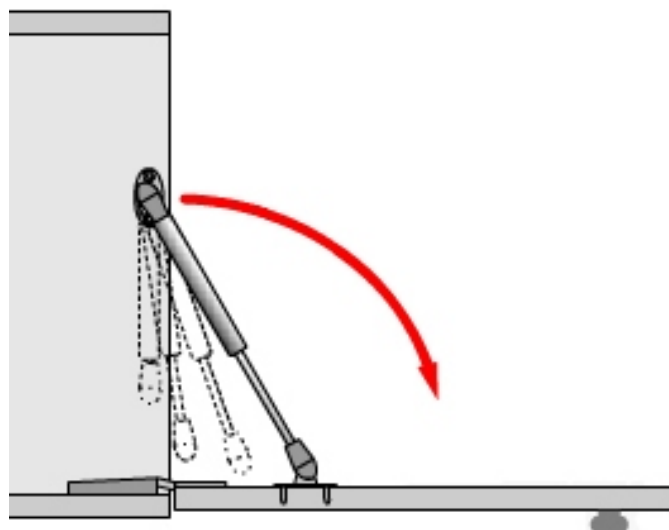

Сглобки



Рафтоносач $\Phi 5$ симетричен
стоманен, покритие никел

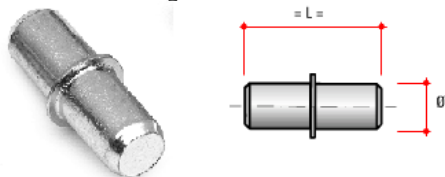

Рафтоносач за стъкло 8мм
ЦАМ покритие никел

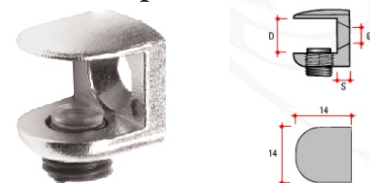

Рафтоносач $\Phi 5$ ъглов
стоманен, покритие никел

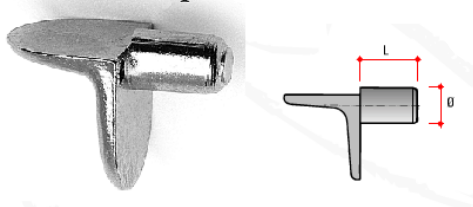

Рафтоносач $\Phi 5$ за стъкло 8мм
ЦАМ покритие никел

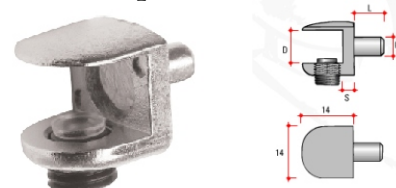

Рафтоносач $\Phi 5$ прозрачен
стомана/пластмаса

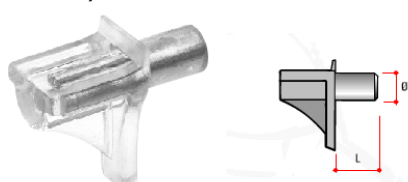

Рафтоносач $\Phi 5$ за стъкло ъглов
ЦАМ покритие никел

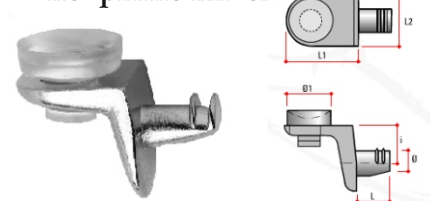

Рафтоносач за стъкло 10мм хром

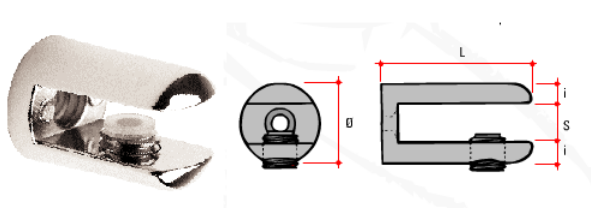

Рафтоносач $\Phi 5$ за стъкло прав
ЦАМ покритие никел



Рафтодържач скрит монтаж, регулируем



Рафтодържач скрит монтаж

размер /мм/
8x100
8x150
10x100
10x150



Рафтоносач за стъкло 10мм
сатен



Конзола квадратна до 14мм
инокс



Конзола пеликан

цвет	размер /см/
инокс	4x20
инокс	4x26
инокс	4x40
хром	4x20
хром	4x26
хром	4x40

Ъгли стоманени, покритие цинк



ЪГЪЛ 20 x 20 x 16 x 1,2



Планка 60 x 13 x 1,2



ЪГЪЛ 30 x 30 x 13 x 1,2



Планка 80 x 16 x 1,2



ЪГЪЛ 40 x 40 x 16 x 1,5



Планка 100 x 16 x 2



ЪГЪЛ 50 x 50 x 16 x 2



Планка 120 x 25 x 2



ЪГЪЛ 60 x 60 x 25 x 2



ЪГЪЛ 100 x 100 x 25 x 2,5



Планка 160 x 27 x 2

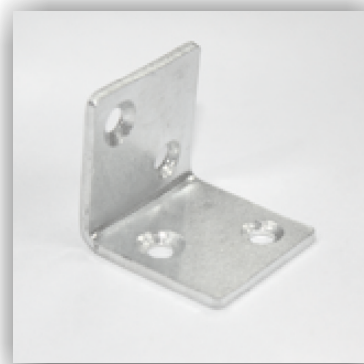

Винкел 25 x 25 x 25 x 2



Подсилен ъгъл 50 x 50 x 20 x 1,2

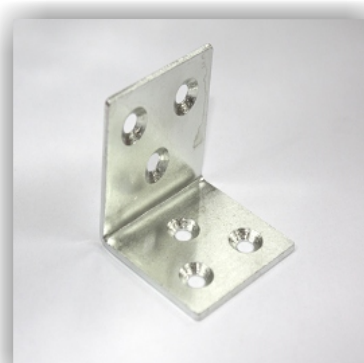

Винкел 40 x 40 x 40 x 2



Подсилен ъгъл 75 x 75 x 20 x 1,2



Равнинен ъгъл 70 x 70 x 12 x 1,5



Триъгълна планка 100 x 100 x 0,8



Равнинен ъгъл 100 x 100 x 20 x 2

Конзола бяла

размер /мм/
100 x 75
125 x 100
150 x 125
200 x 150
250 x 200
300 x 250
350 x 300





Лост 30 x 15

ДЪЛЖИНА /мм/
800
900
1000
1200
3000

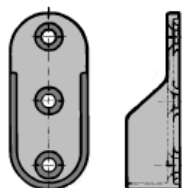

Носач за лост 30 x 15

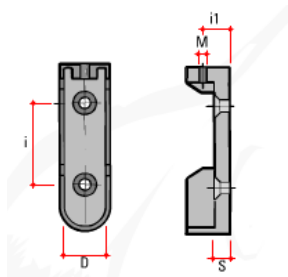

Носач за лост 30 x 15, горен монтаж М6

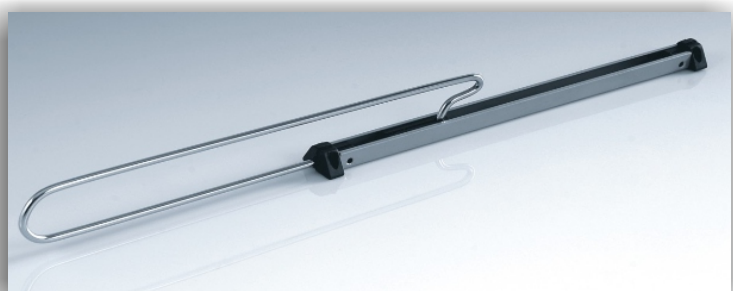

Изтеглящ лост

код	размер /мм/
6061	300
6062	350
6063	400
6064	450



Изтеглящ лост

размер /мм/
250
300
350
400
450

Крак неразглобям

размер /мм/
100
150

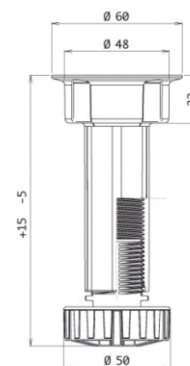

Крак разглобям

размер /мм/
80
100

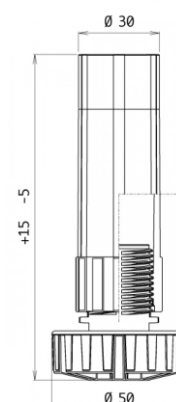
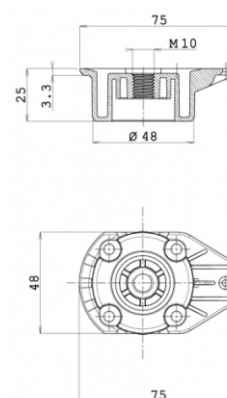

Клипс

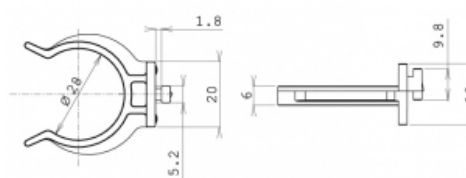

Крака, Колела, Ключалки



Крак квадратен регулируем,
алуминиев

размер /мм/	
40x40	H60
40x40	H100



Ключалка 138
Размер на патрона Ф19 H22



Крак кръгъл регулируем,
алуминиев

размер /мм/	
Ф40	H60
Ф40	H100



Ключалка 138 лукс
Размер на патрона Ф19 H22



Колело

размер /мм/	
Ф40	H55
Ф50	H65



Ключалка за стъкло

МОДЕЛ	
407	ЕДИНЧНО СЪГЪЛО
409	ДВОЙНО СЪГЪЛО



Колело със стопер

размер /мм/	
Ф40	H55
Ф50	H65



Стъпка 27мм с регулиране



Колело с лагер

размер /мм/	
Ф35	H50
Ф50	H65

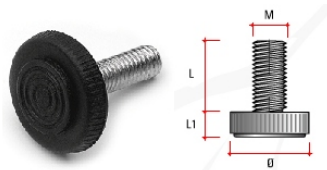

Краче

размер /мм/	
M6	H20
M8	H22



Колело с лагер
със стопер

размер /мм/	
Ф35	H50
Ф50	H65



Кабър

ЦВЯТ
черен
бял
кафяв

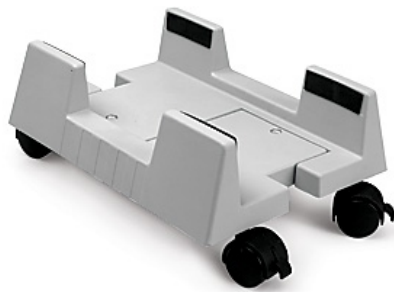

Поставка за компютър

ЦВЯТ
сив
черен



Поставка за клавиатура

ЦВЯТ
сив
черен



Капачка кабели

ЦВЯТ	размер /Фмм/
инокс	Ф60
алуминий	Ф60
сатен	Ф60
инокс	Ф80



Контакти за плот

Крак

ЦВЯТ	размер /мм/
хром	Ф60 Н=710
хром	Ф60 Н=820
хром	Ф60 Н=1100



Дистанционер наклонен за бар, хром

КОД	МОДЕЛ	
7261	дърво-стъкло	Н 210
7262	дърво-дърво	Н 210



Водобрани лайсни L= 4000мм, Профили челен бора

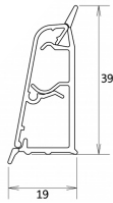
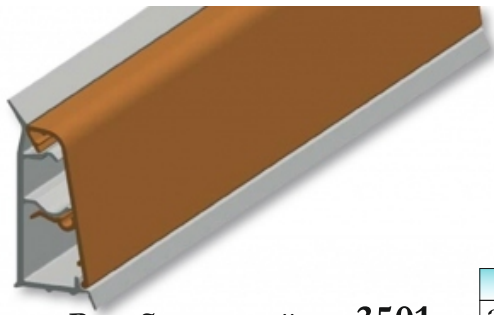

Водобранна лайсна 3501

ЦВЯТ
алуминий

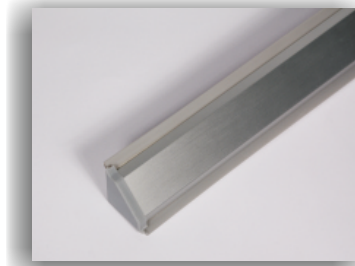

Водобранна лайсна трапец

ЦВЯТ
алуминий

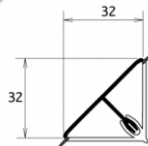
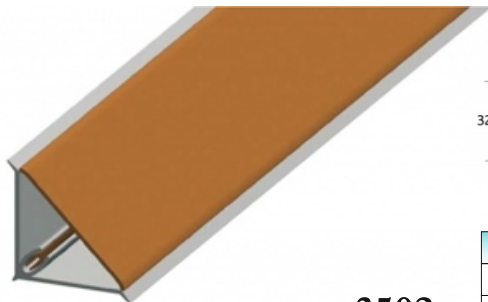

Водобранна лайсна 3502

ЦВЯТ
алуминий
инокс

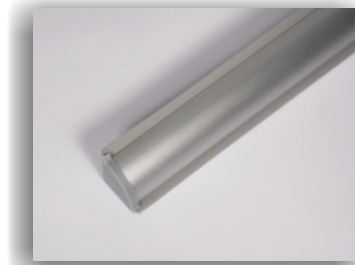

Водобранна лайсна изгъгнала

ЦВЯТ
алуминий

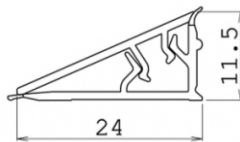

Водобранна лайсна 3504

ЦВЯТ
алуминий
инокс

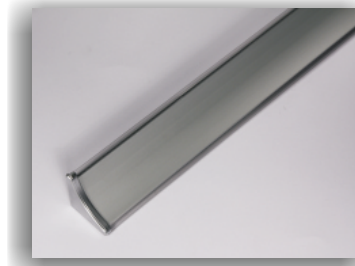

Водобранна лайсна вдлъбната

106
ЦВЯТ
алуминий
хром

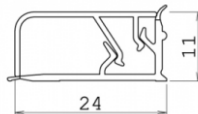

Водобранна лайсна 3505

ЦВЯТ
алуминий
инокс



Алуминиев профил бора

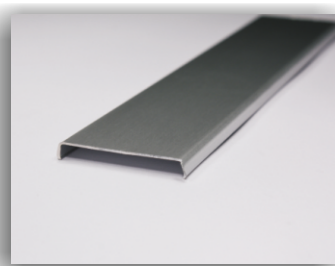

размер /мм/
H28 L3000
H40 L3000

Цокли, Профили за витрина

Цокъл, L= 4000мм



МОДЕЛ	размер /мм/
PVC с алуминиево фолио	100
PVC с алуминиево фолио	150
алуминиев	100

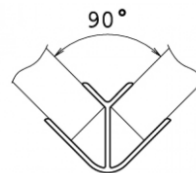

Ъгъл алуминиев
вътрешен-външен 90°

размер /мм/
100
150

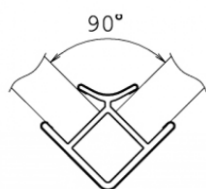

Ъгъл пластмасов алуминиево фолио
вътрешен-външен 90°

размер /мм/
100
150

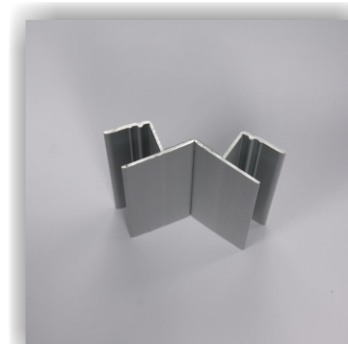

Ъгъл алуминиев
вътрешен-външен гъвкав

размер /мм/
100
150

Алуминиева решетка

размер /мм/
80 x 480
60 x 480



размер /мм/
100
150

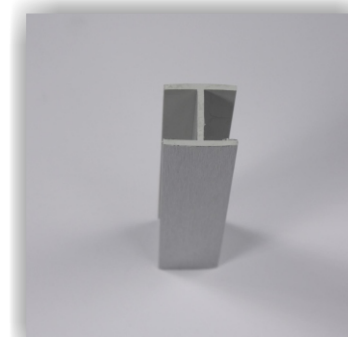

Свързка за цокъл

Профил за витрина
L= 3000 мм

ЦВЯТ
алуминий
хром
жълт

Ъгъл

ЦВЯТ
алуминий
хром
жълт



Дръжки



020

цвят	размер /мм/	
алуминий	192	256



130

цвят	размер /мм/	
алуминий	128	160
инокс	128	160



102

цвят	размер /мм/
алуминий	128



132

цвят	размер /мм/		
алуминий	96	128	160



106

цвят	размер /мм/
алуминий	160
инокс	160



142

цвят	размер /мм/	
алуминий	96	128



107

цвят	размер /мм/
алуминий	128



153

цвят	размер /мм/	
алуминий	128	160
инокс	128	160



126

цвят	размер /мм/		
алуминий	96	128	192



154

цвят	размер /мм/	
алуминий	160	
инокс	160	



128

цвят	размер /мм/		
алуминий	128	160	192
инокс	128	160	192

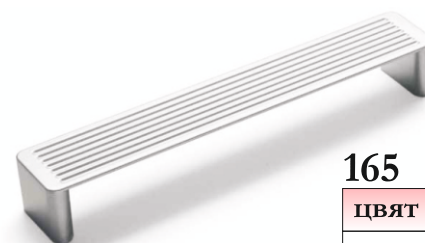

165

цвят	размер /мм/
алуминий	160

Дръжки

169

ЦВЯТ	размер /мм/	
алуминий	128	160
инокс	128	160



187

ЦВЯТ	размер /мм/		
алуминий	128	160	224
инокс	128	160	224
хром	128	160	224



300

ЦВЯТ	размер /мм/
алуминий	32



300

ЦВЯТ	размер /мм/
хром	64

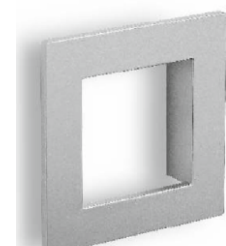

317

ЦВЯТ	размер /мм/
алуминий	32
хром	32

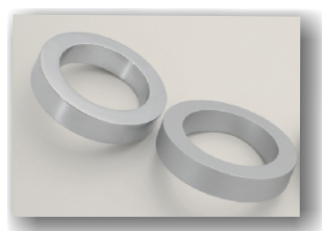

319

ЦВЯТ	размер /мм/
алуминий	—



111

ЦВЯТ	размер /мм/
алуминий	—



112

ЦВЯТ	размер /мм/
алуминий	32



6002

ЦВЯТ	размер /Фмм/		
алуминий	22	28	31
сатен	22	28	31



2024

ЦВЯТ	размер /Фмм/		
алуминий	25	30	35



211

ЦВЯТ	размер /мм/
алуминий	—



Дръжки

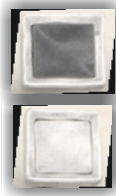

188

цвят	размер /мм/	
сребро + черно	96	единична
сребро + сребро	96	единична

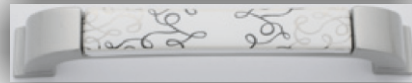

M56

размер /мм/
128

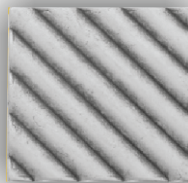
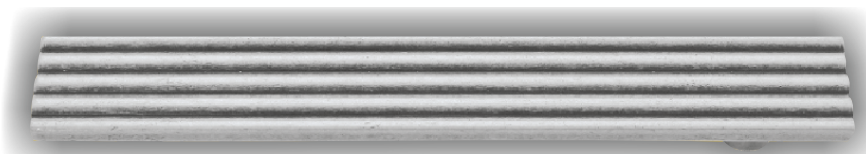

601

цвят	размер /мм/	
сребро	128	32



637

цвят	размер /мм/	
сребро	128	единична
стар стил	128	единична
хром	128	единична



638

цвят	размер /мм/	
сребро	128	32
стар стил	128	32
хром	128	32



532

размер /мм/
128
96



533

размер /мм/
128
96



534

размер /мм/
128
96



536

размер /мм/
128
96
единична



110

размер /мм/
32



120

размер /мм/
128

P07



M01

размер /мм/
96



Дръжки алуминиеви



Дръжка алуминиева 313

размери /мм/
128
160
192



Дръжка алуминиева 319

размери /мм/
96
128
160



Дръжка алуминиева 337B

размери /мм/
128
160
192



Дръжка алуминиева 387

размери /мм/
96
128
160
192
224
256
288
320



Дръжка алуминиева AA-07

размери /мм/
96
128
160
192
224
256
320



Дръжка рейлинг AA-05

цвет	инокс	сатен
размери /мм/	96	96
	128	128
	160	160
	192	192
	256	---
	320	320
	416	—



Дръжка алуминиева AA-04

размери /мм/
128
160
192



Дръжка за вкопаване ф35
кръгла



Дръжка за вкопаване ф35
квадратна



1

цвят	размер /мм/	
сатен	96	128

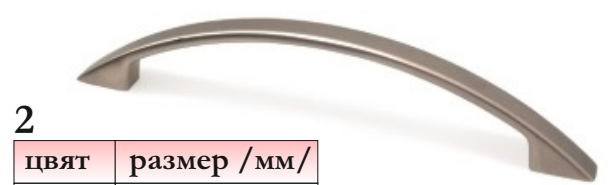

2

цвят	размер /мм/	
сатен	128	



3

цвят	размер /мм/	
сатен	96	



4

цвят	размер /мм/	
сатен	96	128



5

цвят	размер /мм/	
сатен	96	128



7

цвят	размер /мм/	
сатен	96	128



10

цвят	размер /мм/	
алуминий	96	128
сатен	96	128

14

цвят	размер /мм/	
сатен	96	128



16

цвят	размер /мм/	
сатен	96	



10

цвят	размер /мм/	
стар стил	96	

Дръжка морска фауна В

Дръжка морска фауна D



Дръжка морска фауна А

Дръжка морска фауна С

Закачалки



110

цвят
алуминий
сатен



892

цвят
алуминий



“А”

цвят
алуминий
сатен
хром



“В”

цвят
алуминий
сатен
хром



“С”

цвят
алуминий
сатен
хром



Закачалка стар стил

Отцедник неръждаема стомана клас AISI 304

шкаф/мм/	габарит /мм/
450	410
500	460
600	560
650	610
700	660
750	710
800	760
850	810
900	860
950	910
1000	960



Отцедник неръждаема стомана клас AISI 304
/комбиниран/

шкаф/мм/	габарит /мм/
600	560
700	660
800	760
900	860
1000	960



Отцедник неръждаема стомана клас AISI 304
/стоящ 410 мм/



Кошчета



Кош изтеглящ
инокс
300 шкаф, 1 кофа



Кош изтеглящ
алуминий
300 шкаф, 1 кофа



Кош изтеглящ
пластмасов сив
300 шкаф, 1 кофа



Кош изтеглящ
пластмасов сив
300 шкаф, 2 кофи



Кош "Сити" сив
350 шкаф



Кош лукс плавно прибиране
450 шкаф



Кош ринг
алуминий



Кош ринг
инокс



Кош ринг
пластмасов
сив



Кош ринг
пластмасов бял



Кош STAR

КОД	ЦВЯТ
2251	хром
2252	алуминий

Кош закачаш
пластмасов

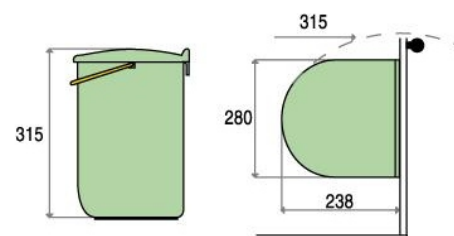

Разделители за прибори



за шкаф 300

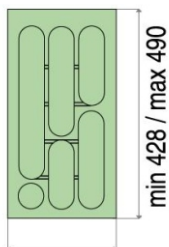

min 204 / max 248



за шкаф 400

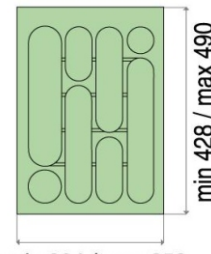

min 304 / max 352



за шкаф 450

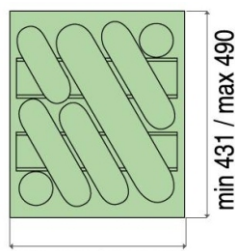

min 350 / max 390



за шкаф 500

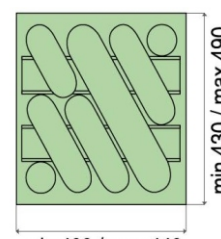

min 400 / max 440



за шкаф 550

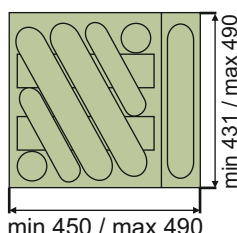

min 450 / max 490



за шкаф 600

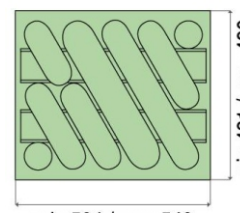

min 504 / max 540



за шкаф 700

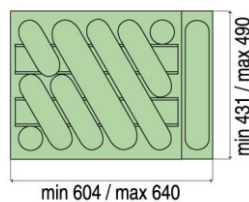

min 604 / max 640



за шкаф 800

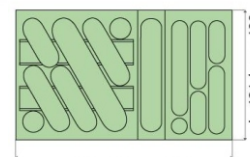

min 701 / max 785



за шкаф 900

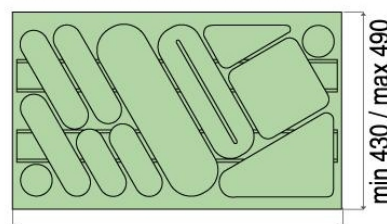

min 800 / max 840



за шкаф 300 цвят мока

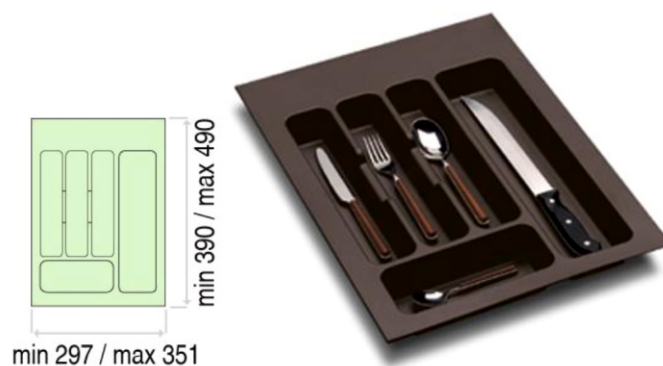

за шкаф 400 цвят мока

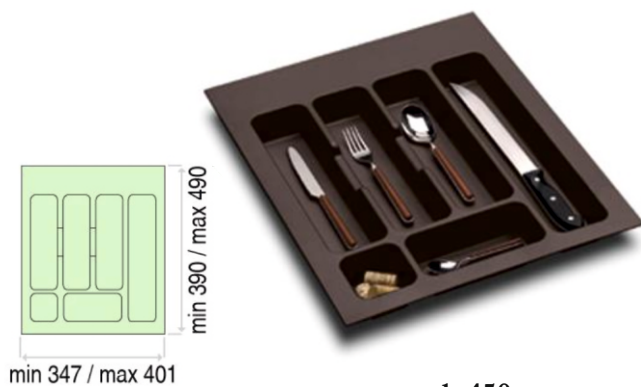

за шкаф 450 цвят мока



за шкаф 500 цвят мока



за шкаф 600 цвят мока

Разделители за прибори



Разделител прибори с място за ножове 600



Разделител прибори с място за ножове 900



Разделител прибори STAR

КОД	шкаф
2281	300
2282	350
2283	400
2284	450
2285	500
2286	550
2287	600
2288	700
2289	800
2290	900

Килер - 100% изтегляне

МОДЕЛ №	ВИСОЧИНА /мм/	шкаф
1113	1100 ÷ 1250	300
1114	1100 ÷ 1250	350
1115	1100 ÷ 1250	400
1116	1100 ÷ 1250	450
1119	1250 ÷ 1400	300
1120	1250 ÷ 1400	350
1121	1250 ÷ 1400	400
1122	1250 ÷ 1400	450
1125	1400 ÷ 1550	300
1126	1400 ÷ 1550	350
1127	1400 ÷ 1550	400
1128	1400 ÷ 1550	450
1131	1550 ÷ 1700	300
1132	1550 ÷ 1700	350
1133	1550 ÷ 1700	400
1134	1550 ÷ 1700	450
1137	1700 ÷ 1850	300
1138	1700 ÷ 1850	350
1139	1700 ÷ 1850	400
1140	1700 ÷ 1850	450
1143	1850 ÷ 2000	300
1144	1850 ÷ 2000	350
1145	1850 ÷ 2000	400
1146	1850 ÷ 2000	450
1149	2000 ÷ 2150	300
1150	2000 ÷ 2150	350
1151	2000 ÷ 2150	400
1152	2000 ÷ 2150	450



Телени аксесоари

Механизъм бутилки



КОД	шкаф /мм/		
2211	150	плавно прибиране	нормално прибиране
2213	200		
2214	260		



Кошница чинии

КОД	шкаф/мм/
2162	400
2163	450
2164	500
2165	550
2166	600
2167	600



Кошница 3 етажа
бутилки
плавно прибиране

КОД	шкаф/мм/
2120	300
2121	350
2122	400
2123	450
2124	500



Кошница 2 етажа
бутилки
плавно прибиране

КОД	шкаф/мм/
2100	300
2101	350
2102	400
2103	450
2104	500



Телено чекмедже

шкаф/мм/
300
350
400
450
500
600
700



Чекмедже за чинии
плавно прибиране

КОД	шкаф/мм/
2233	600

Ъглов механизъм 3/4
Ф600
Ф720



Магически ъгъл

КОД	шкаф	
3001	450	ЛЯВО
3002	450	ДЯСНО

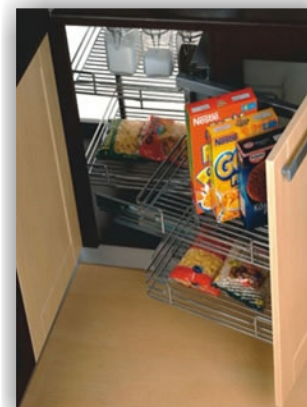

Ф720
Ъглов механизъм 1/2



Магически ъгъл

КОД	шкаф	
3013	450	ЛЯВО
3014	450	ДЯСНО



Ъглов механизъм 45°

КОД	шкаф	
2201	250	ЛЯВО
2202	250	ДЯСНО



Поставка сухи чаши

КОД	шкаф
5052	600
5054	700
5056	800
5058	900



Поставка сухи чинии

КОД	шкаф
5155	600
5156	700
5157	800
5158	900



Отцедник

КОД	шкаф
5159	600
5160	700
5161	800
5162	900



Телени аксесоари

Механизъм панталони



КОД	шкаф/мм/
6023	400
6024	450
6025	500
6026	550
6027	600

Механизъм панталони



6545



6052

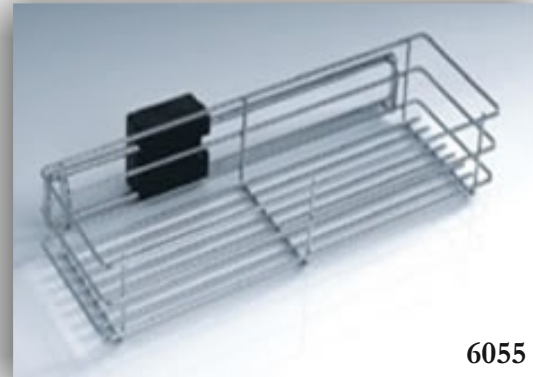

6055

Кош за пране
/преносим/



КОД	шкаф/мм/
8112	350
8113	400

Кош за пране



КОД	шкаф/мм/
8011	300
8012	350
8013	400
8014	450
8015	500

Телени аксесоари за кухни и гардероби



Механизъм панталони
алуминиев

КОД	шкаф/мм/
6205	600
6206	700
6207	800
6208	900



Чекмедже
алуминиево

КОД	шкаф/мм/
6225	600
6226	700
6227	800
6228	900

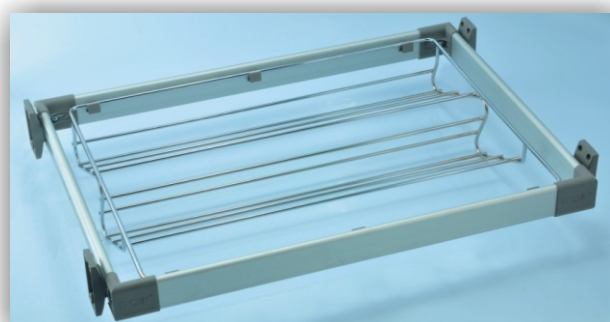

Механизъм обувки
алуминиев

КОД	шкаф/мм/
6205	600
6206	700
6207	800
6208	900



Полица обувки

КОД	L /мм/
6111	420 ÷ 700

Единичен



КОД	шкаф/мм/
6131	600
6132	700
6133	800
6134	900

Двоен

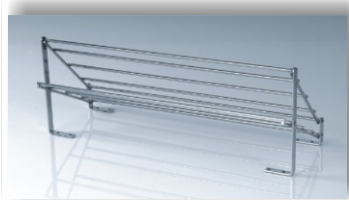

КОД	шкаф/мм/
6141	600
6142	700
6143	800
6144	900

Телен механизъм обувки



Телени аксесоари за кухни и гардероби



4001



4002



МОДЕЛ
4003
4004



МОДЕЛ
4005
4006
4007

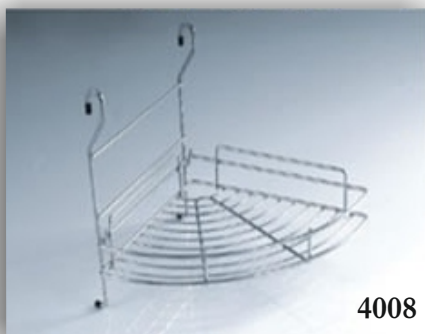

4008

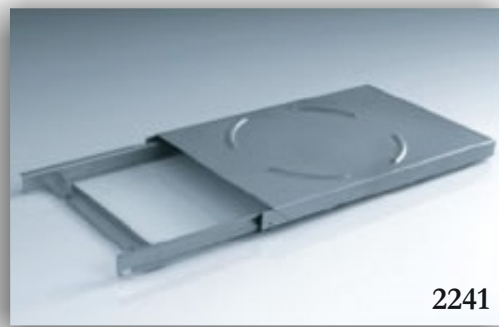

2241

Поставка
газова бутилка



4014



4016 - два реда

4043 - четири реда



Тръба

КОД	размер /мм/
4061	500
4062	600
4063	800
4064	1000
4065	1200



Кука

4091



Държател тръба

4085

Чекмедже под мивка, плавно прибиране



КОД	шкаф/мм/
2085	800
2086	900

Лифт за гардероб

размер/мм/	цвет	
	520*700	хром
700*1000	хром	алуминий
800*1300	хром	алуминий



Дъска за гладене 6611



Аксесоари за бар



Мивки



760 x 434
101 - гладка
102 - лен



730 x 480
103 - гладка
104 - лен



Ф480
107 - гладка
108 - лен



48 x 46
109 - гладка
110 - лен



620 x 480
111 - гладка
112 - лен



780 x 480
113 - гладка
114 - лен



580 x 480
117 - гладка
118 - лен



620 x 480
119 - гладка
120 - лен



100 x 48
127 - гладка
128 - лен



780 x 50
115 - гладка
116 - лен



Φ520
125 - гладка
126 - лен



440 x 440
131 - гладка



780 x 440
133 - гладка



460 x 370
141 - гладка



600 x 500
145 - гладка
146 - лен



380 x 380
147 - гладка



495 x 475
149 - гладка
150 - лен

Представяме ви кухненски мивки от гранитни частици с антибактериални сребърни йони.

Мивките са направени от естествени гранитни частици и полимери. Тези мивки изглеждат като направени от естествен камък, но качествата им са много по-добри. За постигане на максимална здравина от напукване при температурни разлики, влага и механично нараняване, всяка гранитна частица е обвита в полимер. Така получената гранитна смес е еднородна по цялата дебелина на изделието.

В естествена среда гранита променя цвета си, но поради причината, че гранитните частици са покрити с полимер и на практика нямат допир с околната среда, следва непроменяем цвят при тези мивки.

В допълнение към тези качества в гранитната смес са добавени антибактериални сребърни йони "IONPURE".



Бежово 110

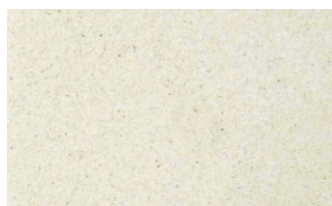

Силиций 111

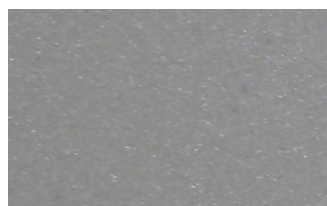

Алуметалик 202

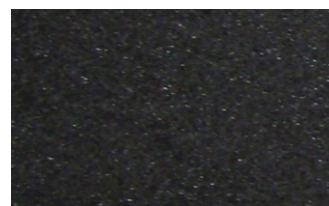

Черен Металик 601



Смесител 522



Смесител 2560



SQ102
Размер 575 x 460
Корито 320 x 390 x 185



SQ101
Размер 765 x 460
Корито 320 x 390 x 195



SQC100
Размер 490 x 455
Корито 425 x 345 x 190
SQS100
Размер 425 x 500
Корито 350 x 390 x 190



SQC101
Размер 780 x 495
Корито 345 x 425 x 190



SR100
Размер Φ 505
Корито Φ 395 x 190



SR101
Размер 780 x 500
Корито Φ 420



SQC150
Размер 610 x 495
Корито малко 160 x 350
Корито 345 x 425 x 190



SQC151
Размер 800 x 495
Корито малко 160 x 350
Корито 345 x 425 x 190

Осветление



Триъгълен панел с ключ
12V 20W

ЦВЯТ
ИНОКС
ХРОМ

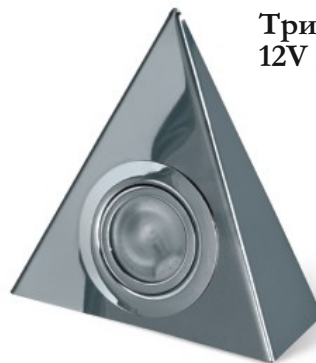

Триъгълен панел без ключ
12V 20W

ЦВЯТ
ИНОКС
ХРОМ



Комплект 2 луни+трансформатор и кабели
ИНОКС



Комплект 3 луни+трансформатор и кабели
ИНОКС



Комплект 4 луни+трансформатор и кабели
ИНОКС



Комплект 5 луни+трансформатор и кабели
ИНОКС



Трансформатор 220V-12V

МОДЕЛ
60W
105W
150W



Луна 12V 20W

ЦВЯТ
ИНОКС
ХРОМ
АЛУМИНИИ



Луна Квадратна LED
220V
инокс



Луна Къгла LED
220V
инокс



Триъгълен панел LED
1,5W 12V
инокс



Трансформатор LED
220V-12V 6W



Осветително Тяло
12V 2x20W
No90
инокс



Осветително тяло
12V 20W
No30
инокс



Осветително тяло
12V 20W
No80
инокс

Планки за греди

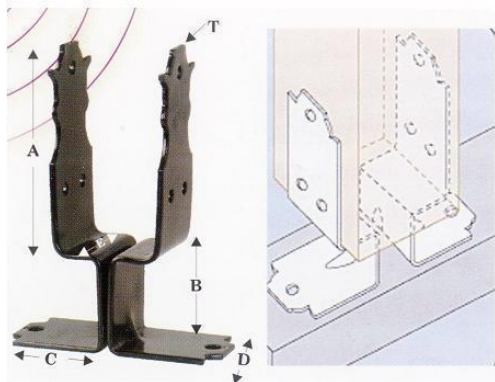

214

Планка за греда 2 части комплект
Размери мм

A	B	C	D	T	E
132	64	80	66	4	34

Цвят черен

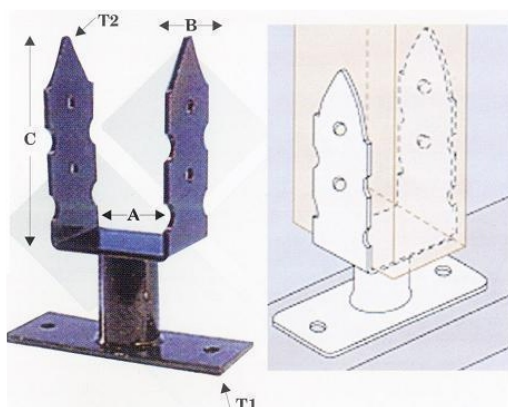

215

Планка за греда 10 см
Размери мм

A	B	C	T1	T2
100	60	140	5	3,5

Цвят черен

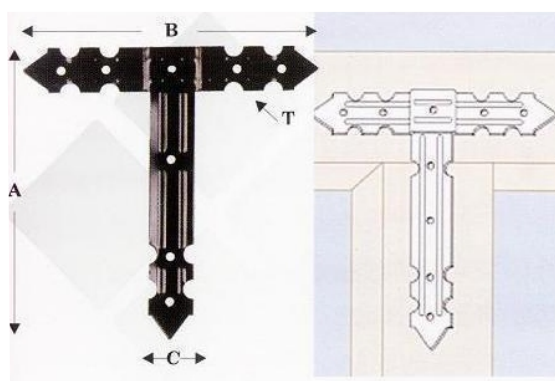

217

Планка Т
Размери мм

A	B	C	T
315	315	48	2,5

Цвят черен

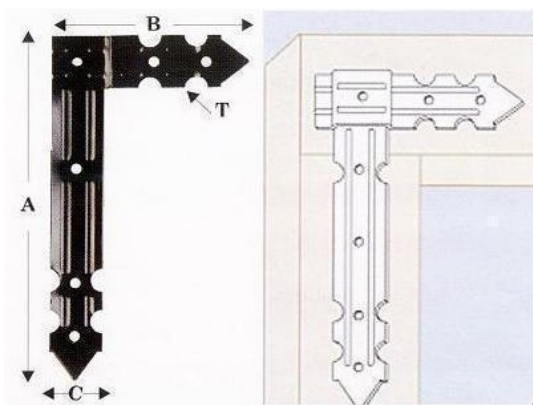

218

Планка Г
Размери мм

A	B	C	T
315	195	48	2,5

Цвят черен

Ъгъл 50 x 50

Размери мм:

A	B	C	T
50	50	40	2

Цвят: бял цинк, черно

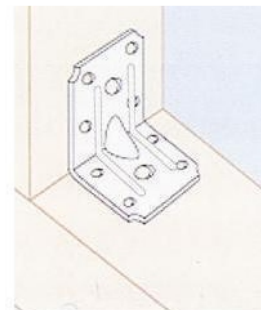
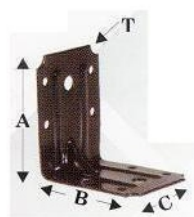

Ъгъл 70 x 70

Размери мм:

A	B	C	T
70	70	50	2

Цвят: бял цинк, черно

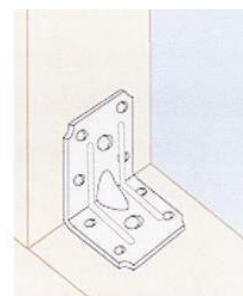
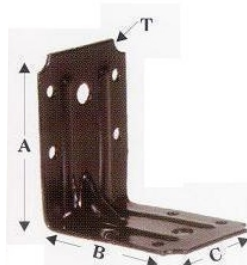

Ъгъл 90 x 90

Размери мм:

A	B	C	T
90	90	65	2

Цвят: бял цинк, черно

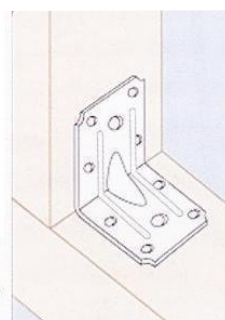
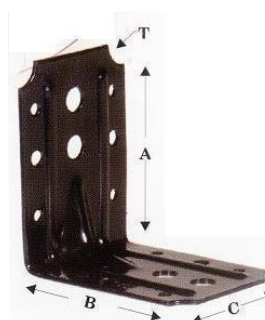

Ъгъл 130 x 130

Размери мм:

A	B	C	T
130	130	70	2,5

Цвят: бял цинк, черно

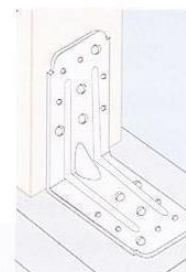

239

Ъгъл за греда

Размери мм: 210 x 210 x 56

Цвят: черен

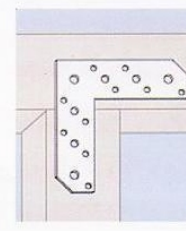
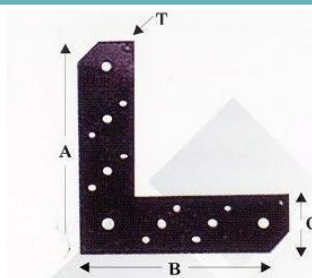

Планки за греди

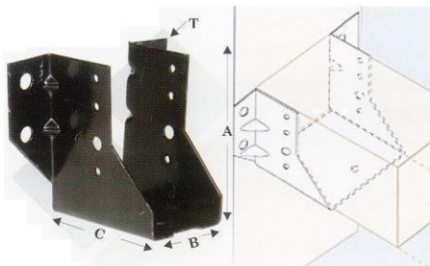

216

Планка за греда 9см 90°

Размери мм:

A	B	C	T
90	90	85	2

Цвят: черен

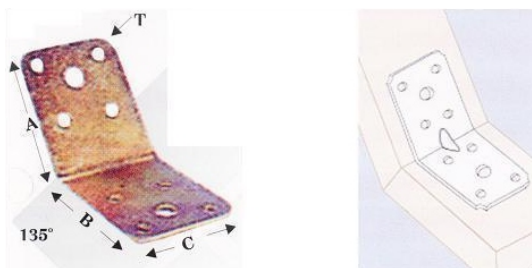

233

Ъгъл 135°

Размери мм:

A	B	C	T
70	70	52	2

Цвят: ЖЪЛТ ЦИНК

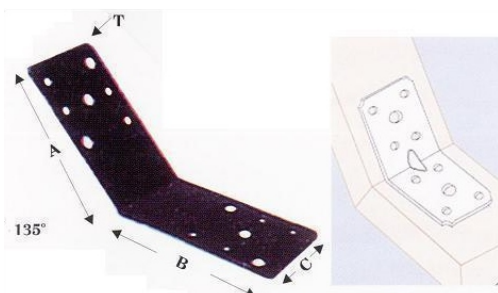

234

Ъгъл 135°

Размери мм:

A	B	C	T
130	130	70	2,5

Цвят: черен



236

Права планка

Размери мм:

A	B	C
160	60	2

Цвят: черен

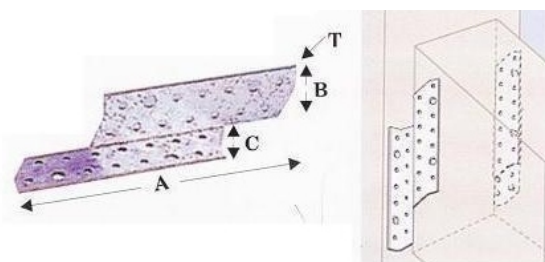

240

Планка за греда Лява/Дясна/ Комплект

Размери мм:

A	B	C	T
220	40	40	2

Цвят: ЖЪЛТ ЦИНК